



19011109A01

1. Overview

Thank you for purchasing the GL10-4PT module developed and manufactured independently by Inovance.

GL10-4PT is a 4-channel thermal resistor temperature collection module used together with the AM600 series medium-sized PLC and the H3U series PLC main modules. It supports temperature collection of multiple types of thermal resistors, and provides a resolution of up to 24 bits.

This guide describes the specifications, characteristics and using methods of the product. Read this guide carefully before using to ensure more safely usage. See the Medium-Sized PLC Programming Manual to understand the use of the user program development environment and design method of the user program of the product. You can download the latest materials from [www.inovance.com](http://www.inovance.com).

2. Safety Information and Precautions

Safety information and precautions are identified into two grades: Warning and Caution. Please make sure to operate properly with adequate safety assurance.

**WARNING** Indicates the improper operation which, if not avoided, may cause death or serious injury;

**CAUTION** Indicates the improper operation which, if not avoided, may cause moderate or minor injury, as well as equipment damage.

In some cases, even failure to follow "Cautions" may also lead to serious consequences. Please make sure to follow both warnings and cautions; otherwise, it may cause death or serious injury, as well as product and relevant equipment and system damage.

Please keep this guide well so that it can be read when necessary and forward this guide to the end user.

During control system design

- WARNING**
  - Provide a safety circuit outside the PLC so that the control system can still work safely once external power failure or PLC fault occurs.
  - Add a fuse or circuit breaker because the module may smoke or catch fire due to long-time overcurrent caused by operation above rated current or load short-circuit.

- CAUTION**
  - An emergency stop circuit, a protection circuit, a forward/reverse operation interlocked circuit, and a upper position limit and lower position limit interlocked circuit must be set in the external circuits of the PLC to prevent damage to the machine.
  - To ensure safe operation, for output signals related to critical accidents, please design external protection circuit and safety mechanism;
  - Once the PLC CPU detects abnormality in the system, all outputs may be closed; however, when a fault occurs in the controller circuit, the output may not be under control. Therefore, it is necessary to design an appropriate external control circuit to ensure normal operation;
  - If the PLC's output units such as relays or transistors are damaged, the output may fail to switch between ON and OFF states according to the commands;
  - The PLC is designed to be used in indoor electrical environment (overvoltage category II). The power supply must have a system-level lightning protection device, assuring that overvoltage due to lightning shock can't be applied to the PLC's power supply input terminals, signal input terminals and output terminals and so forth, so as to avoid damage to the equipment.

During installation

- WARNING**
  - Installation must be carried out by the specialists who have received the necessary electrical training and understood enough electrical knowledge.
  - Disconnect all external power supplies of the system before module assembly/disassembly and wiring. Failure to do so may result in electric shock, module fault or malfunction.
  - Do not use the PLC where there are dust, oil smoke, conductive dust, corrosive or combustible gases, or exposed to high temperature, condensation, wind & rain, or subject to vibration and impact. Electric shock, fire and malfunction may also result in damage or deterioration to the product.
  - The PLC is open-type equipment that must be installed in a control cabinet with lock (cabinet housing protection > IP20). Only the personnel who have received the necessary electrical training and understood enough electrical knowledge can open the cabinet.

- CAUTION**
  - Prevent metal filings and wire ends from dropping into ventilation holes of the PLC during installation. Otherwise it may result in fire, fault and malfunction.
  - Ensure there are no foreign matters on the ventilation surface. Failure to comply may result in poor ventilation, which may cause fire, fault and malfunction.
  - The module is connected to the respective connector securely and hook the module firmly. Improper installation may result in malfunction, fault or fall-off.

During wiring

- WARNING**
  - Wiring must be carried out by personnel who have received the necessary electrical training and understood enough electrical knowledge.
  - Disconnect all external power supplies of the system before wiring. Failure to comply may result in electric shock, module fault or malfunction.
  - Install the terminal cover attached to the product before power-on or operation after wiring is completed. Failure to comply may result in electric shock.
  - Perform good insulation on terminals so that insulation distance between cables will not reduce after cables are connected to terminals. Failure to comply may result in electric shock or damage to the equipment.

- CAUTION**
  - Prevent metal filings and wire ends from dropping into ventilation holes of the PLC at wiring. Failure to comply may result in fire, fault and malfunction.
  - The external wiring specification and installation method must comply with local regulations. For details, see the wiring section in this guide.
  - To ensure safety of equipment and operator, use cables with sufficient diameter and connect the cables to ground reliably.
  - Wire the module correctly after making clear of the connector type. Failure to comply may result in module and external equipment fault.
  - Tighten bolts on the terminal block in the specified torque range. If the terminal is not tight, short-circuit, fire or malfunction may be caused. If the terminal is too tight, fall-off, short-circuit, fire or malfunction may be caused.
  - If the connector is used to connect with external equipment, perform correct crimping or welding with the tool specified by manufacturer. If connection is in poor contact, short-circuit, fire or malfunction may be caused.
  - A label on the top of the module is to prevent foreign matters entering the module. Do not remove the label during wiring. Remember to remove it before system operation, facilitating ventilation.
  - Do not bundle control wires, communication wires and power cables together. They must be run with distance of more than 100 mm. Otherwise, noise may result in malfunction.
  - Select shielded cable for high-frequency signal input/output in applications with serious interference so as to enhance immunity to interference of the system.

During maintenance & inspection

- WARNING**
  - Maintenance & inspection must be carried out by personnel who have the necessary electrical training and experience.
  - Do not touch the terminals while the power is on. Failure to comply may result in electric shock or malfunction.
  - Disconnect all external power supplies of the system before cleaning the module or re-tightening screws on the terminal block or screws of the connector. Failure to comply may result in electric shock.
  - Disconnect all external power supplies of the system before removing the module or connecting/removing the communication wirings. Failure to comply may result in electric shock or malfunction.

- CAUTION**
  - Get acquainted with the guide and ensure safety before online modification, forcible output, and RUN/STOP operation.
  - Disconnect the power supply before installing/removing the extension card.

At disposal

- CAUTION**
  - Treat scrapped module as industrial waste. Dispose the battery according to local laws and regulations.

3. Product Information

Model and Nameplate

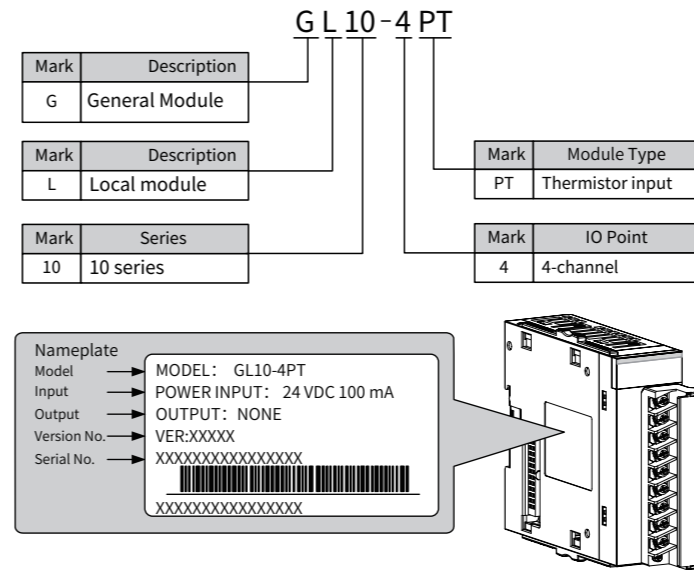

Figure 1 Description of model and nameplate

Model	Classification	Description	Applicable to
GL10-4PT	Temperature module	4-Channel thermal resistor temperature collection module, supporting multiple types of thermal resistors	AM600 series, H3U

External Interfaces

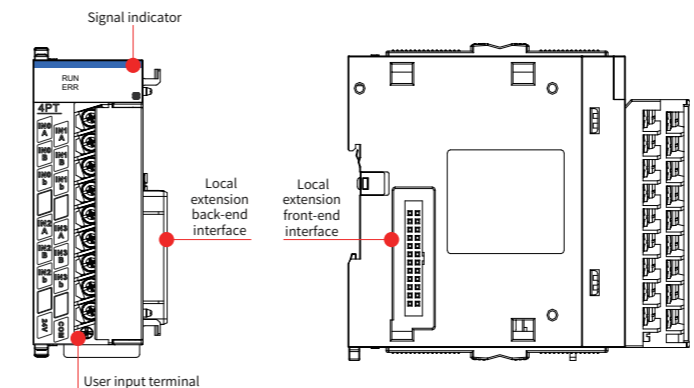

Figure 2 Diagram of the GL10-4PT temperature module interfaces

Interface Name	Function
User input terminals	4 channels of thermal resistor inputs
Signal indicators	RUN: operation state indicator, which is turned on during normal operation and turned off when a fault occurs ERR: error state indicator, which is turned on when a fault occurs
Local expansion module back-end interface	Connect back-end module, not supporting hot plugging
Local expansion module front-end interface	Connect front-end module, not supporting hot plugging

General Specifications

Item	Specifications
Input channel	4
Supply voltage	24 VDC (20.4 VDC to 28.8 VDC) (-15% to +20%)
Internal 5 V power consumption	85 mA (typical value)
Sensor type	Thermal resistor: Pt100, Pt500, Pt1000, and Cu100
Display mode:	Celsius degree (°C), and Fahrenheit degree (°F)
Thermal resistor wiring method	Two wires/Three wires
Resolution	24 bits
Sensitivity	0.1 °C or 0.1 °F
Sampling cycle	250 ms, 500 ms, or 1000 ms (The sampling cycles of the four channels can be set separately using software.)
Filter time	0s to 100s (The filter time can be set using software. The default value is 5s.)
Accuracy (normal temperature: 25 °C)	Full scale x (±0.3%)
Accuracy (ambient temperature: 0 to 55 °F)	Full scale x (±1%)

Item	Specifications
Isolation method	I/O terminals isolated from power supply; Isolation between channels
System program updated via	USB interface

4. Mechanical Design Reference

Mounting Dimensions

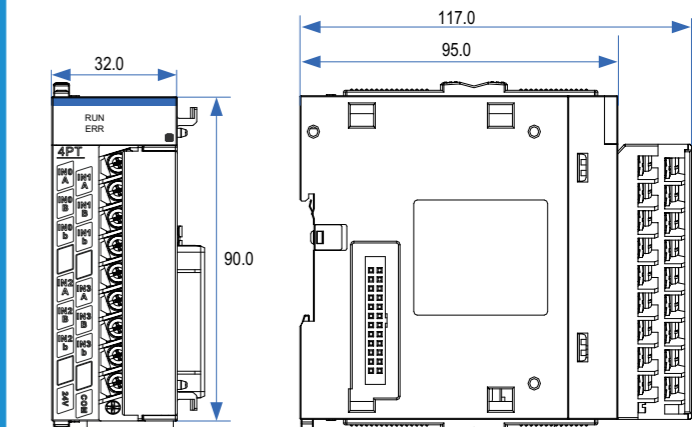

Figure 3 Mounting dimensions (in mm)

5. Electrical Design Reference

Cable Selection

Cable Name	Model	Applicable Cable Diameter		Manufacturer	Crimping Tool
		Chinese standard/ MM <sup>2</sup>	American standard/ AWG		
Y-shaped cable lug	TNS 1.25-3	0.5-0.75	22-18	Suzhou Yuanli	RYO-8 YYT-8

Those cable lugs are applicable to digital and analog temperature modules, and the cable rated temperature needs to be higher than 75 °C.

Cable Preparing Procedures

- Strip the insulation layer of the cable by 6 mm.
- Pass the cable through the tube of proper wire size.
- Insert the exposed end into the hole of the cable lug, and then crimp it with the recommended crimping tool.
- Use a 20 mm heat-shrinkable tube (Φ3) to wrap the copper tube of the cable lug and then perform thermal shrinkage.

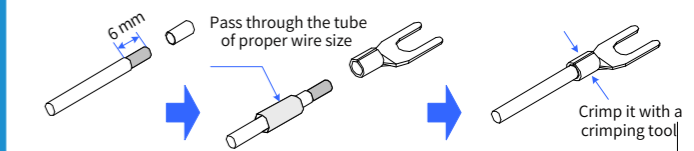

Figure 4 Diagram of cable preparation

- Put the cable lug onto the terminal and tighten the screw with a screwdriver. The tightening torque cannot be greater than 0.8 N.m.

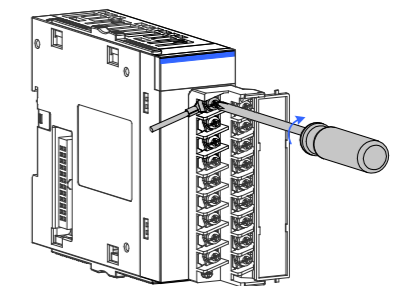

Figure 5 Connecting cable to terminal block

Terminal Arrangement

The figure below shows the ports of the GL10-4PT module.

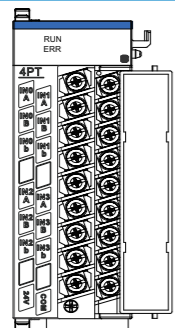

Figure 6 Terminal definition of the GL10-4PT module

Terminal Definition

Network Name	Type	Function	Terminal No.
IN0 A	Input	Temperature measurement resistor A of channel 0	1
IN0 B	Input	Temperature measurement resistor B of channel 0	3
IN0 b	Input	Temperature measurement resistor b of channel 0	5
IN1 A	Input	Temperature measurement resistor A of channel 1	2
IN1 B	Input	Temperature measurement resistor B of channel 1	4
IN1 b	Input	Temperature measurement resistor b of channel 1	6
IN2 A	Input	Temperature measurement resistor A of channel 2	9
IN2 B	Input	Temperature measurement resistor B of channel 2	11
IN2 b	Input	Temperature measurement resistor b of channel 2	13
IN3 A	Input	Temperature measurement resistor A of channel 3	10
IN3 B	Input	Temperature measurement resistor B of channel 3	12
IN3 b	Input	Temperature measurement resistor b of channel 3	14
NC	Reserved	Reserved	7
NC			8
NC			15
NC			16
24 V	Power supply	+24 V power supply	17
COM	Power supply	24 V power ground	18

Detection Mode Specifications

Item	Sensor	Temperature Range (°C)	Temperature Range (°F)
Thermal Resistor Type	Pt100	-200.0 °C to 850.0 °C	-328.0 °F to 1562.0 °F
	Pt500	-200.0 °C to 850.0 °C	-328.0 °F to 1562.0 °F
	Pt1000	-200.0 °C to 850.0 °C	-328.0 °F to 1562.0 °F
	Cu00	-50.0 °C to 150.0 °C	-58.0 °F to 302.0 °F

External Wiring

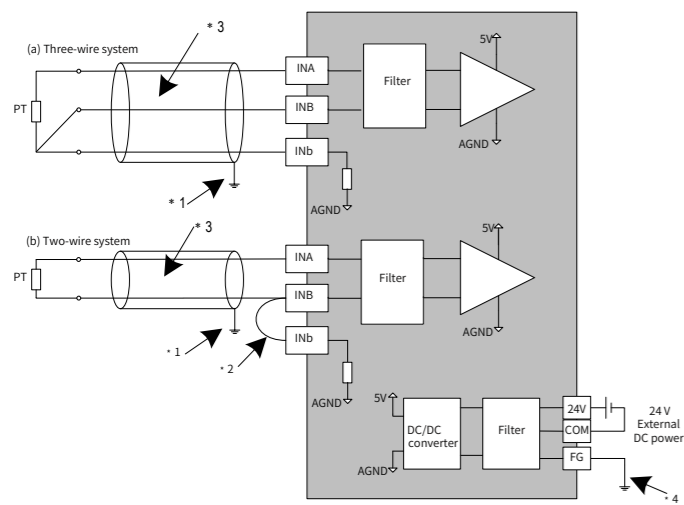

Figure 7 GL10-4PT module wiring diagram

- \*1. Shielded cables need to be used.
- \*2. When the two-wire system is used in wiring, the INB and INb channels need to be shorted. In this case, resistors on the cable affect the measurement value.
- \*3. Cables with low wire resistance in which there is no resistance difference among the three wires need to be used.
- \*4. The module should be mounted on a well-grounded metal bracket, and the metal shrapnel at the bottom of the module must be in good contact with the bracket.

Wiring Precautions

Do not bundle the cable together with AC cable, main lines, high voltage cable and so forth; otherwise, it may result in an increased noise, surge and induction. Apply single-point grounding for the shielding of shielded cable and solder sealed cable.

Tubed and solderless crimp terminal cannot be used with a terminal block. It is recommended that a marking sleeve or insulation sleeve be used to cover the cable connector part of the crimp terminals.

6. Programming Examples

Programming Example for the AM600+GL10-4PT Modules

Descriptions are given below by using an example in which channel 0 of the GL10-4PT module uses the PT100 thermal resistor, a sampled value is assigned to a corresponding variable, and the AM600 module is used as the main control module.

- 1) Create a project and perform hardware configuration as follows:

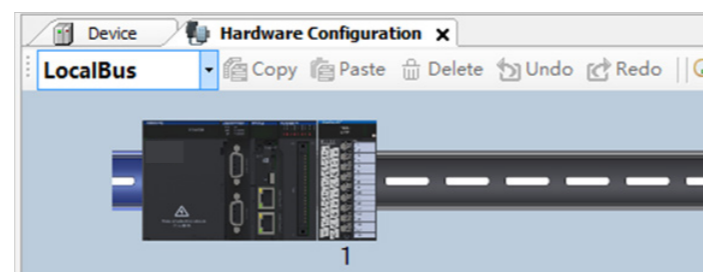

- 2) Double-click the GL10-4PT module, and set parameters such as Module diagnosis upwards reported based on actual requirement on the GenericConfiguration interface.

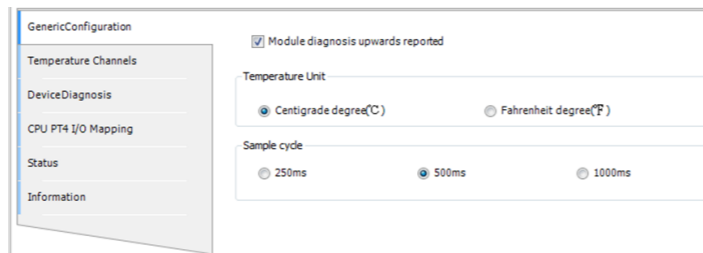

- 3) Select Enable access on the Temperature Channels interface, set Sensor Type to Pt100, and set other parameters as required.

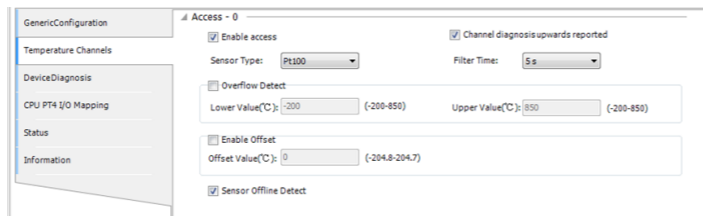

- 4) Use the ST programming language for programming, as shown in the figure below. Define variables CH0 and PT\_CH0, and assign the sampled value of CH0 of channel 0 to PT\_CH0.

```

1 PROGRAM FOU
2 VAR
3   CH0:REAL;
4   PT_CH0:REAL;
5
6 END_VAR
7
8 //
9 PT_CH0:=CH0;
    
```

- 5) Map the variable CH0 tag defined during programming to channel 0 of the configured GL10-4PT module to complete variable mapping.

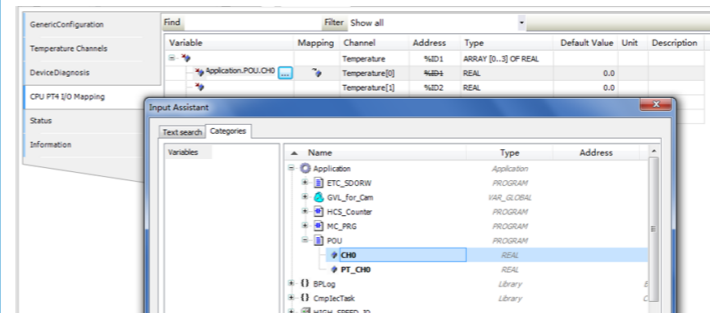

- 6) After the project is successfully compiled, log in to download the project and run it.

Programming Example for H3U + GL10-4PT Module

- 1) Create a project, and select "H3U". Then the system enters the main page. ① Double-click "Module Config". ② The simulation graphics of the rack to be configured is displayed.

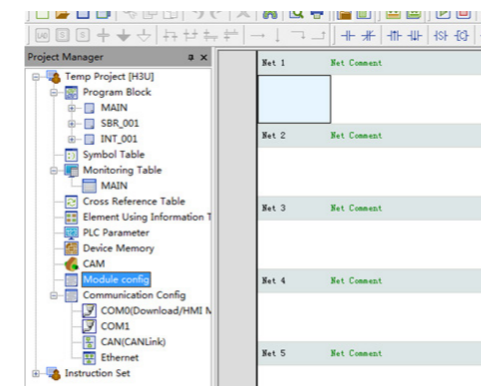

- 2) Select the module GL10-4PT to be added from the module list. Double-click the module to automatically add it to the expansion rack, or hold the left button to drag the module to the expansion rack.

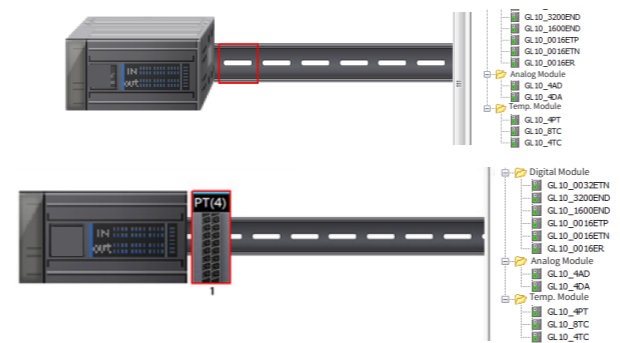

- 3) Double-click the GL10-4PT module on the rack. The configuration interface is displayed (as below). On the 4PT Configuration tab page, select Centigrade (°C) in the Temperature unit area, and select 500ms in the Sampling period area.

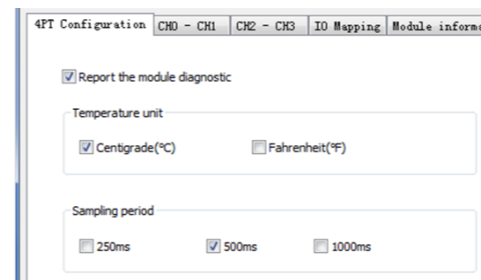

- 4) On the CH0 - CH1 tab page, select Enable channel and set Sensor type to Pt100 in the CH - 0 area.

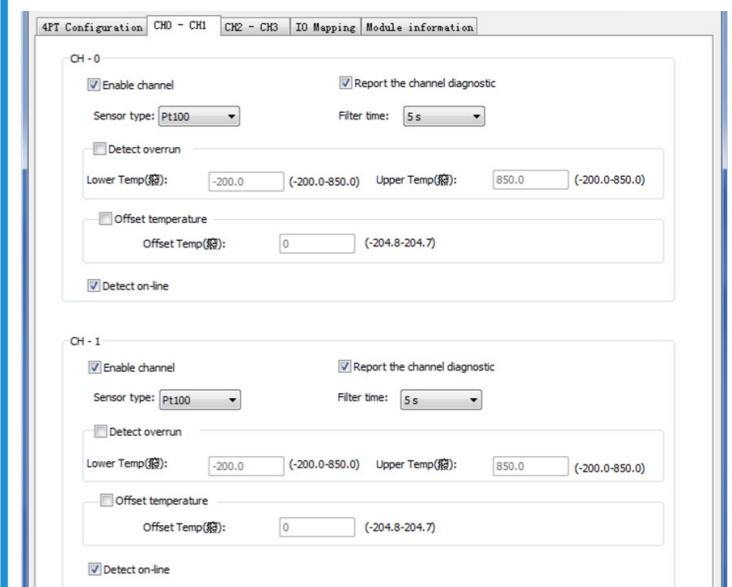

- 5) On the IO Mapping tab page, map CH0 of the 4PT module to D0 of element D.

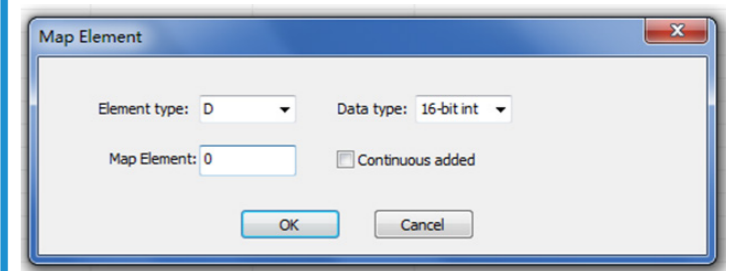

- 6) Use the ladder graphic programming language to program 4PT sampling. Move the sampled temperature of channel 0 from D0 to D200.

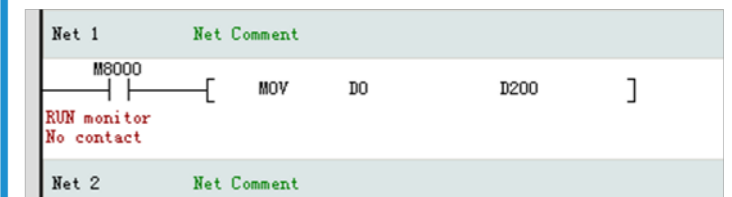

- 7) After the project is successfully compiled, download the project and run it.

INOVANCE Warranty Agreement

- 1) Inovance provides an 18-month free warranty to the equipment itself from the date of manufacturing for the failure or damage under normal use conditions.
- 2) Within the warranty period, maintenance will be charged for the damage caused by the following reasons:
  - a. Improper use or repair/modification without prior permission
  - b. Fire, flood, abnormal voltage, natural disasters and secondary disasters
  - c. Hardware damage caused by dropping or transportation after procurement
  - d. Operations not following the user instructions
  - e. Damage out of the equipment (for example, external device factors)
- 3) The maintenance fee is charged according to the latest Maintenance Price List of Inovance.
- 4) If there is any problem during the service, contact Inovance's agent or Inovance directly.
- 5) Inovance reserves the rights for explanation of this agreement.

Suzhou Inovance Technology Co., Ltd.  
 Address: No.16, Youxiang Road, Yuexi Town, Wuzhong District, Suzhou 215104, P.R. China  
 Website: <http://www.inovance.com>